



b.o.b. Sistemi Idraulici S.p.A.

unilift[®]

AZIENDA CON SISTEMA
DI GESTIONE QUALITÀ
CERTIFICATO DA DNV
= ISO 9001 =

HOOKLIFT « TL 26 »

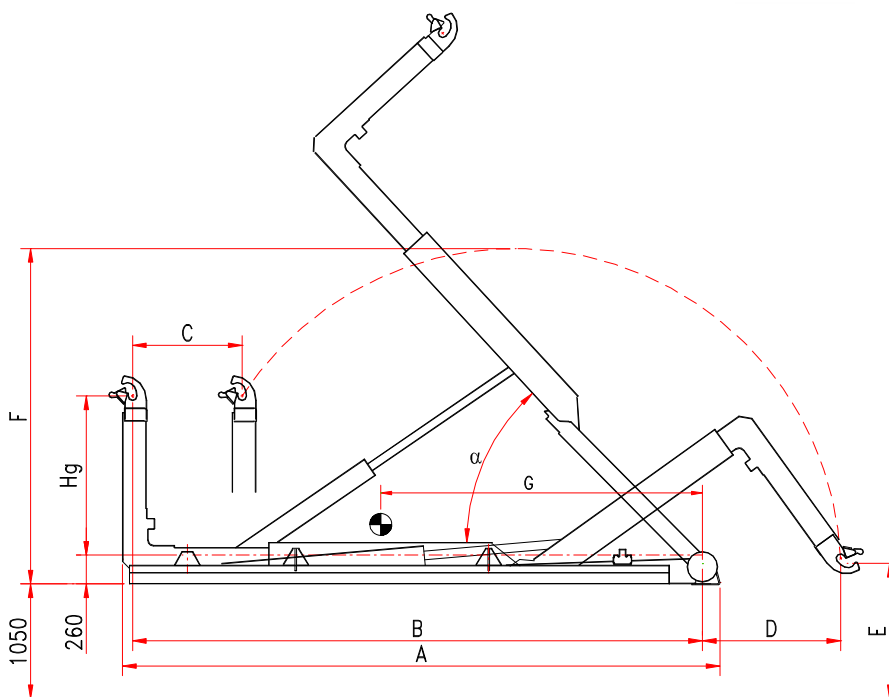

Model	HG	A	B	C	D	E	F	G	Weight kit	α	Container	min - max	
TL 26 C	1.425/1.570	5.985	5.730	1.300	1.480	1.220	3.290	3.200	3.050 kg	54°		4.800	6.800
TL 26 NC	1.425/1.570	6.185	5.930	1.300	1.280	1.220	3.290	3.350	3.100 kg	51°		5.000	7.000
TL 26 N	1.425/1.570	6.385	6.130	1.300	1.080	1.220	3.290	3.500	3.150 kg	48°		5.200	7.200
TL 26 NL	1.425/1.570	6.585	6.330	1.300	880	1.220	3.290	3.650	3.200 kg	46°		5.400	7.400
TL 26 L	1.425/1.570	6.785	6.530	1.300	680	1.220	3.290	3.800	3.250 kg	44°	5.600	7.600	

The technical details shown in this sheet are indicative and can be changed by the builder without prior notice

B.O.B. Sistemi Idraulici S.p.A. – Regione Oltre Rea, 32 – 12060 Monchiero (CN) - Italia
P. I.V.A. 00496180043 - Tel.: +39 (0173) 780002/3 – Fax: +39 (0173) 780004
Internet: www.bobspa.com - E-mail: info@bobitalev.com