



GT 22-10
AERIAL PLATFORM



3.5 t

7716 lbs

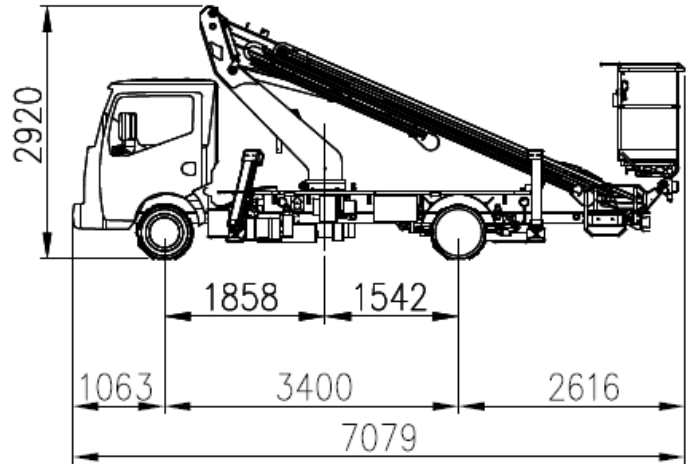
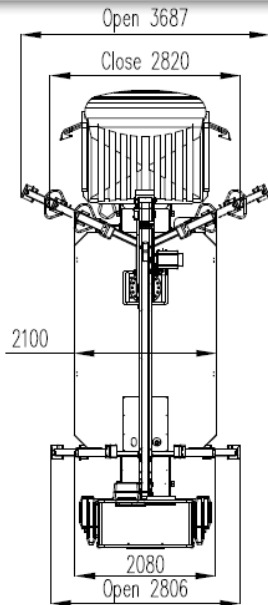

REV. 03/2016

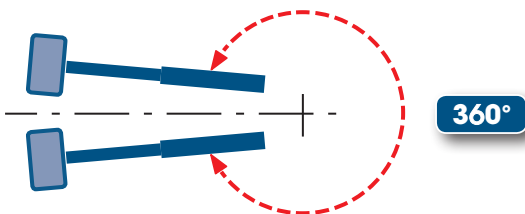
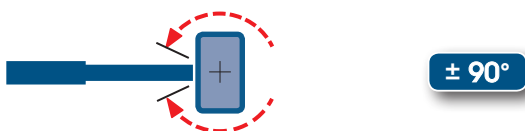
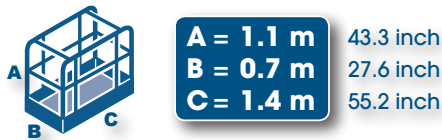
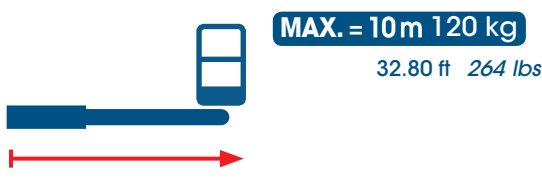
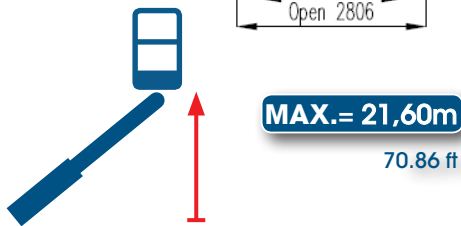

HYDRAULIC PROPORTIONAL

